



PRODUCT GUIDE

ONE STOP SHOP COFFEE SOLUTION



BONCAFÉ

Segafredo
— ZANETTI —

TEMPESTA
BARISTA ATTITUDE

la marzocco
handmade in florence

GLAYE R
espresso machines

FAEMA

SM
Espresso coffee machines since 1920

modbar

ECM
MANUFACTURE

MAHLKÖNIG

Hey
Café

thermoplan

CaféMATIC

PUQ | precision
PRESS | coffee
tampers

 **Vitamix**

BRODIES
ESTD 1867

Torani

 **FETCO**

 **BWT**
water + more

 **BONcafetto**

marco

BONCAFÉ

M I D D L E E A S T L L C

Boncafe was established in Singapore in 1962 and founded Boncafe Middle East in 2003 evolving into becoming a leading manufacturer and supplier of fresh roast and ground gourmet coffee. A renowned distributor of domestic and commercial coffee machines and producers of a variety of beverage mixes and along with our partners in Switzerland, Singapore, Thailand, Cambodia, Hongkong, Malaysia and Vietnam. Boncafe has become one of the leading suppliers and roasters of fine coffee in the region.

Boncafe Middle East is a proud member of Massimo Zanetti Beverage Group, which acquired full equity share capital of the entire Boncafe Group inclusive of the roasting plants in Thailand and Singapore. The Massimo Zanetti Beverage Group is the largest and well known in the coffee industry and owns a network of successful companies and international brands such as Segafredo Zanetti, Chock full o'Nuts, Kauai and Hill Bros (USA), and Meira (Finland).

Complete One-stop Shop for Coffee Solution

Boncafe Middle East offers the complete package from the finest gourmet coffee blends, premium coffee machines and equipment brands all in addition to the full Segafredo Zanetti portfolio. With our extensive range of coffee & beverage products & service we provide a strong portfolio and a 'one stop shop' for coffee shop design or the complete beverage supply solution. Offering preventative maintenance programs, technical assistance, formidable after sales support, certified Barista training courses and beverage menu development these services are available through our experienced and professional in-house Barista Trainers, mixologist, our certified and highly skilled technical & maintenance team.

Our clients are thirsty for both fine gourmet coffee and coffee knowledge, ours is the role of the advisor and educator to provide this 'complimentary' specialist service through the art of coffee making and various level of training courses to ensure our clients make the finest coffees and beverages that can ultimately be produced!

International and Export

As a major exporter of coffee and other premium products, Boncafe Middle East are key supplier to distinguished HORECA & Foodservice companies throughout the Middle East and South East Asia, with a continued support to our customers with an impeccable after sales service wherever their operations develop.

Origin & Production

Carefully selected Thai beans are a combination of Arabica beans from the 'Misty Mountains' of the North, and Robusta beans from the 'Red Earth' soil which are roasted and blended to perfection at the company's own roasting plant using the most modern fluid-bed roasting technology.

Segafredo boasts of coffee plantations in Brazil with Nossa Senhora Da Guia considered as the largest single plantation in the world, Hawaii, Costa Rica and Vietnam. Coffees are cultivated and picked with the most accurate control at each stage guaranteeing a superior and constant quality from the plant to the cup and always employ production techniques that are sustainable and environmental friendly.

Quality

Boncafe and Segafredo coffee laboratories assure stringent quality control and tractability of each single production batch. Modern packaging technology (nitrogen-flushing, one way valves) and pressurized tins preserve the unique coffee flavours, aromas and taste guaranteeing consistent great top quality and freshness.

BONCAFÉ

Boncafé Gourmet coffees are roasted in Italy with blends created from combinations of high grade Arabica and Robusta beans sourced from Central and South America, Africa and India. Each coffee profile combination provides different bodies and flavours for a truly Italian espresso taste.

Our foodservice customers include leading international airlines, luxury hotels, resort, restaurants, cafés, exclusive clubs, food and beverages establishment, international corporations and businesses.

Within the Boncafé roasting facilities in Italy, Thailand and Vietnam our coffee blends follow strict and high level quality control production and traceability options.



ITALIAN GOURMET COFFEE BLENDS | ITALY

100% ITALIAN GOURMET COFFEE



CAFÉ ESPRESSA

Our top gourmet coffee, Strong and full bodied with slight acidity.

Roast :	○○○
Body :	○○○○○
Acidity :	○○
Aroma :	Chocolate and spice
Tasting Note :	Dark chocolate



Whole Beans
500g

Certified by the quality seal of "Gruppo Triveneto Torrefattori Caffè" and guaranteed by the seal "Italian Quality Espresso".



CAFÉ DELISSIMA

Rich and nutty full bodied flavours with a thick crema.

Roast :	○○○
Body :	○○○○○
Acidity :	○○
Aroma :	Smoky
Tasting Note :	Rich and Nutty



Whole Beans
500g



CAFÉ ELITA

Sweet and almost spicy with a chocolaty taste, medium acidity and luxurious crema.

Roast :	○○○
Body :	○○○○○
Acidity :	○○○
Aroma :	Woody
Tasting Note :	Chocolate, note of spice



Whole Beans
500g



CAFÉ ITALIANO

Rich and intense with a sharp fruity acidity tone and rich crema.

Roast :	○○○○○
Body :	○○
Acidity :	○○
Aroma :	Dark wood scent
Tasting Note :	Bitter-sweet, cremalized



Whole Beans
500g

PREMIUM COFFEE BLENDS



ROYALE COFFEE

Pleasantly strong brew that is both full-bodied and aromatic.

Roast:	○○○○○
Body:	○○○○○
Acidity:	○○
Aroma:	Dark and aromatic
Tasting Note:	Bitter sweet, mild citrus acidity

Whole Beans
500g



GOURMET COFFEE

Enticing blend of velvety smooth indulgence.

Roast:	○○○○
Body:	○○○○○
Acidity:	○○○
Aroma:	Bright and lively
Tasting Note:	Velvety smooth with nutty tones

Whole Beans
500g



CLASSIC COFFEE

Unique blend that bold in character and the intense flavour, thus bring the force.

Roast:	○○○○○
Body:	○○○○○
Acidity:	○
Aroma:	Strong and rich aroma
Tasting Note:	Earthy rustic flavour

Whole Beans
500g



SINGLE ORIGIN COFFEE | UAE



ETHIOPIA YIRGACHEFFE

Tasting notes
Jasmine, Lemon
Cake & Pear

Region: Yirgacheffe
Variety: Heirloom
Process: Washed
Altitude: 1950



ETHIOPIA SIDAMO

Tasting notes
Tea like Fruity
Hint of Cocoa

Region: Sidamo
Variety: Heirloom
Process: Fully Washed
Altitude: 1950



GUATEMALA

Tasting notes
Jasmine, Rose Water,
Lemon, Vanilla
& Apricot

Region: Antigua
Variety: Caturra
Process: Fully Washed
Altitude: 1450



COLOMBIA

Tasting notes
Plum, Cherry Syrup
& Milk Chocolate

Region: Huila
Variety: Caturra
Process: Fully Washed
Altitude: 1750

BONCAFÉ



PREMIUM ESPRESSO

Strong tropical fruit punch flavour with a smooth creamy finish.

100% Arabica



PREMIUM SUNRISE

Distinctive caramel sweetness with the hint of vanilla. Perfect for milk

Blend of Arabica and Robusta



PREMIUM ALL DAY

Rich creamy and bursting milk chocolate taste with intense bold aroma with cocoa aftertaste.

Blend of Arabica and Robusta



COFFEE BLENDS

BONCAFÉ



GOURMET GROUND COFFEE

A satisfying rich profile with a mild body, light acidity and smoky aroma.

Roast :	○○○○
Body :	○○
Acidity :	○
Aroma :	Smoky
Tasting Note :	Rich and Nutty



Ground
500g



CAFÉ DECAFFEINA

Smooth and mellow flavour and aroma.

Roast :	○○○○
Body :	○
Acidity :	○
Aroma :	Chocolate and fruity
Tasting Note :	Chocolate, hint of citrus



Whole Beans
250g



CAFÉ DECAFFEINA

Smooth and mellow flavour and aroma.

Roast :	○○○○
Body :	○
Acidity :	○
Aroma :	Chocolate and fruity
Tasting Note :	Chocolate, hint of citrus



Ground
250g

INSTANT COFFEE STICKS



FREEZE FRIED INSTANT COFFEE

Premium and Decaffeinated

The quality of full flavored aroma and smooth taste.

Carton Packing:
2g x 200 sticks



AGGLOMERATED INSTANT COFFEE

Classic and Decaffeinated

is a very balanced instance coffee with smooth and mellow taste

Carton Packing:
2g x 200 sticks



BONCREMA

Non-Dairy Creamer

Provides the perfect touch to enhance your coffee with its rich and creamy taste.

Carton Packing:
3g x 200 sticks





SEGAFREDO ZANETTI is one of the brands owned by Massimo Zanetti Beverage Group, present in Italy and worldwide in more than 100 countries through all distribution channels. From bar to restaurant, catering, large scale distribution, office coffee service and household, SEGAFREDO ZANETTI brings everywhere in the world a boundless passion for coffee, which made the brand become the Ambassador for the Italian espresso culture worldwide.



EXTRA STRONG

Made with the highest quality beans containing a high percentage of high altitude Arabica varieties with well balanced acidity, full bodied coffee and a smooth strong unique taste.

Roast :	○○○
Body :	○○○
Acidity :	○
Aroma :	Spicy & slightly malty
Tasting Note :	Chocolate, hint of hazelnut, citrus



Whole Beans
1kg



MASSIMO

Features sweet tones and a full bodied selection of high quality beans staying true to the authentic Italian espresso. Hints of chocolate can also be found in Massimo making it perfect for Mocha coffees.

Roast :	○○○
Body :	○○○○
Acidity :	○
Aroma :	Chocolate, note of spice
Tasting Note :	Dark chocolate, citrus & floral



Whole Beans
1kg



BUONO

With its complex yet light notes of citrus, floral and hazelnut highlights; Buono by Segafredo Zanetti is a wonderful smooth blend which can be enjoyed at any time.

Roast :	○○○
Body :	○○○○
Acidity :	○
Aroma :	Hazelnut, toasted cocoa
Tasting Note :	Chocolate, hint of citrus



Whole Beans
1kg





(1kg | 500g)

CLASSICO NAPOLI

Is the true classic with great character and intense aroma, ideal for a pleasant break at any time of the day.

Roast:	○○○
Body:	○○○○○
Acidity:	
Aroma:	Sweet cocoa
Tasting Note:	Chocolate, Note of spice



(250g)

CLASSICO NAPOLI

Is the true classic with great character and intense aroma, ideal for a pleasant break at any time of the day.

Roast:	○○○
Body:	○○○○○
Acidity:	
Aroma:	Sweet cocoa
Tasting Note:	Chocolate, Note of spice



(1kg | 500g)

ESPRESSO ROMA

A blend of the best qualities of Arabica and Robusta, for a creamy coffee with an intense aroma.

Roast:	○○○
Body:	○○○○○
Acidity:	
Aroma:	Hazelnut, Plum
Tasting Note:	Dark chocolate



(250g)

ESPRESSO ROMA

A blend of the best qualities of Arabica and Robusta, for a creamy coffee with an intense aroma.

Roast:	○○○
Body:	○○○○○
Acidity:	
Aroma:	Hazelnut, Plum
Tasting Note:	Dark chocolate



TURKISH COFFEE

Tantalizing dark blend, mild in flavour

Roast:	○○○○
Body:	○○○○
Acidity:	○○
Aroma:	Smoky and nuttyness
Tasting Note:	Bitter-sweet chocolate

Ground
250g



TURKISH COFFEE WITH CARDAMOM

Tantalizing dark blend, mild in flavour with a subtle hint of cardamom.

Roast:	○○○○
Body:	○○○○
Acidity:	○○
Aroma:	Smoky and nuttyness
Tasting Note:	Bitter-sweet chocolate

Ground
250g

100% BIODEGRADABLE AND COMPOSTABLE



ESPRESSO

Round and Intense



LUNGO

Intense and Aroma



RISTRETTO

Rich and Subtle



DECAF

Mild and Balanced

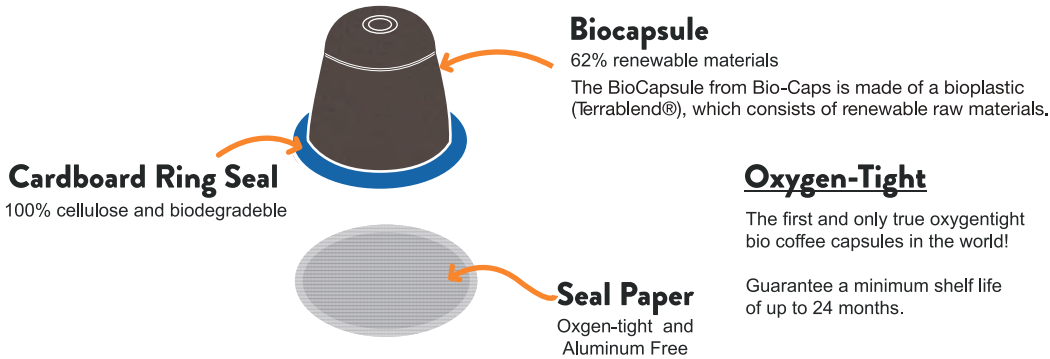

Oxygen-Tight

The first and only true oxygentight bio coffee capsules in the world!

Guarantee a minimum shelf life of up to 24 months.

Aluminum Free

Through the use of our biodegradable seal paper, our biocapsule is completely free from aluminium!

Product Life Cycle

The Home Compostable Capsules not only in industrial composting plants, but also in domestic gardens.

In domestic compost the biocapsule requires a period of **23 weeks**.

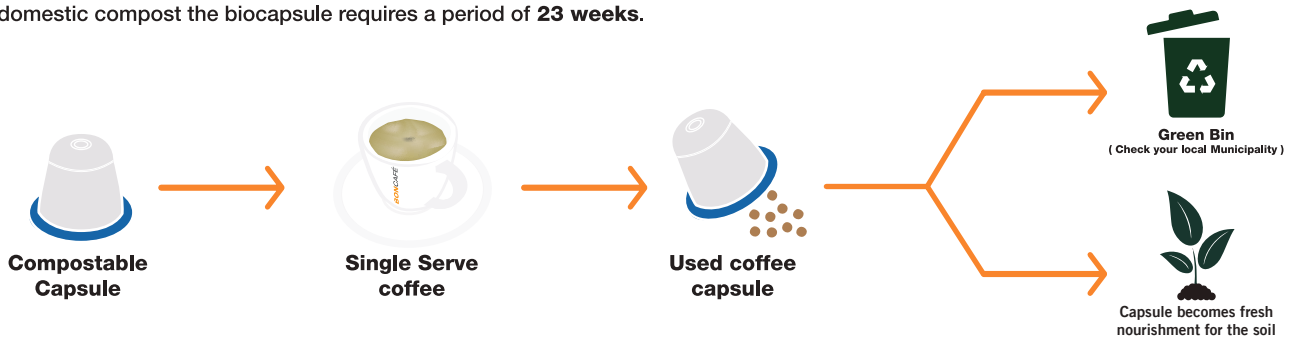

NESPRESSO® COMPATIBLE



*This brand is owned by a third party which has no connection whatsoever with Boncafé Middle East LLC and Segafredo Zanetti.



**NESPRESSO®
COMPATIBLE**



*This brand is owned by a third party which has no connection whatsoever with Boncafe Middle East LLC and Segafredo Zanetti.



Crema Ricca | Lungo | Espresso Casa | Etiopia | Brasile
100% BIODEGRADABLE AND COMPOSTABLE CAPSULES

Blend of roasted ground coffee in single serve capsule packed in a protective atmosphere.



Classico | Intenso | Decaf
ESPRESSO PER TE COMPATIBLE CAPSULES

Blend of roasted ground coffee in single serve capsule packed in a protective atmosphere.



Espresso Cremoso | Lungo | Ristretto | Cappuccino
MIO CAFFÉ COMPATIBLE CAPSULES

Blend of roasted ground coffee in single serve capsule packed in a protective atmosphere.



GOLD Freeze Dried Instant Coffee

Rich and Aromatic, a carefully selected blend of coffee beans, gently roasted for aromatic freshness, in a cup anytime.

CLASSIC Granulated Instant Coffee

Intense and Smooth, a carefully selected blend of coffee beans, gently roasted and agglomerated for aromatic freshness, in a cup anytime.

*This brand is owned by a third party which has no connection whatsoever with Boncafe Middle East LLC and Segafredo Zanetti.



Torani[®]

FLAVOURING SYRUPS | 750ml per bottle

Made with pure cane sugar, natural flavors and cold-filtered water, Torani Original Syrups provide gold-standard flavors and vibrant colors to create amazing drink experiences.



Available Flavours:

Almond Roca | Apple | Blackberry | Blueberry | Butterscotch | Caramel | Classic Caramel | Chai Tea Spice | Cheesecake | Cherry | Chocolate MInt | Cinnamon | Coconut | Creme Caramel | Creme De Menth | Creme De Banana | French Vanilla | Grape | Hazelnut | Honey Vanilla | Irish Cream | Lemon | Lime | Mango | Passion Fruit | Peach | Peppermint | Pineapple | Pomegranate | Raspberry | Strawberry | Tangerine | Tiramisu | Vanilla



Sugar Free Flavours:

Classic Caramel | French Vanilla | Hazelnut Classic | Chocolate

Ideal for:



Flavours Lattes



Italian Sodas



Iced Teas



Mochas



Smoothies



Frozen Coffees

PUREMADE SYRUPS | 750ml per bottle

Torani Puremade Syrups deliver amazing flavor with no artificial flavors or preservatives, using only colors from natural sources, and no GMOs.



Available Flavours :

Vanilla | White Peach | French Vanilla | Strawberry | Chocolate Milano | Signature Vanilla | Salted Caramel | Hazelnut | Caramel | Raspberry | Cane Sugar | Maple

Available Zero Sugar Flavours :

Vanilla | Caramel | Hazelnut

Ideal for :



PUREMADE SAUCES | 64 fl. oz. bottle

The same amazing sauce experience with no artificial flavors, colors or preservatives. Delivering the flavor that consumers are craving with the pure and simple ingredients they demand.

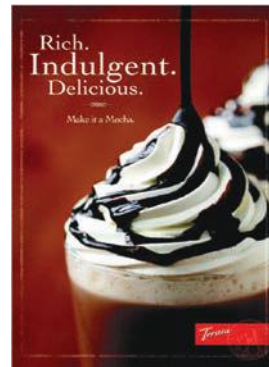

Available Flavours:

Caramel Sauce | White Chocolate Sauce | Dark Chocolate Sauce

Ideal for :



ACCESSORIES



Torani syrups wire rack, 3 tier
Nicely displays 3 - 750 ml Torani syrups.



Torani syrups wire rack 6 tier
Nicely displays 6 - 750 ml Torani syrups.



Torani sauce wire rack, 3 tier
Nicely displays 3 - Torani sauces



Torani Syrup 750 ml Pump
Pumps 1/4 ounce of Torani 750 ml flavoring syrups.



Torani Sauce Pump
Fits 64 oz sauce. Dispenses 1/2 oz.

BONBEVERAGES



BONCHOCO

Instant Chocolate Mix | 1kg

Smooth and Creamy with Dutch-processed cocoa and lactoval (calcium fortified)!



Beverages Mix | 1kg

Our master blenders have developed a range of Iced Blended beverage mixes that deliver true summer café indulgence.

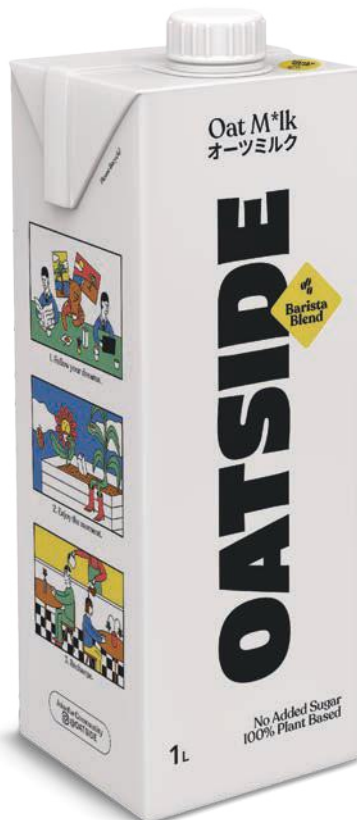

Barista Blend

- **PERFECTLY BALANCED**
Creamy enough for a rich mouthfeel, but allowing coffee/tea notes to shine through
- **BARISTA-GRADE**
Froths to create the silkiest, densest microfoam for latte art
- **GUILT-FREE**
100% plant-based, no saturated fats, lactose-free, no added sugar with natural sweetness coming from oats
- **ONLY REAL INGREDIENTS**
Roasted Australian oats, no added-flavors, gums, emulsifiers
- **GOOD FOR YOU**
Contains beta glucans for digestive and heart health (soluble fibers), high in calcium (100-120mg/100ml)





BIODEGRADABLE
15
TEA PYRAMIDS

PYRAMID TEA

Earl Grey with Cornflower Petals

A delicate black tea scented with bergamot.

Breakfast

A quality blend, full bodied & refreshing.

Peppermint

Refreshing, soothing and naturally caffeine free.

Red Berry Crush

Revitalising, fruity and naturally caffeine free.

Camomile

Calming, relaxing and naturally caffeine free.

Green Tea with Japanese Cherry

Light, fragrant and refreshing.

TAG & ENVELOPE
20
TEA BAGS



TEA BAGS

Earl Grey
Delicate and Scented

Darjeeling
The Champagne of Teas

Breakfast
Reach and Flavourful

Afternoon
Bright and Refreshing

Green Tea
Light and Refreshing

Green Tea with Lemon
Light with Hints of Citrus

Decaffeinated
Rich and Refreshing



INFUSION TEA BAGS

Lemon & Ginger

Peppermint

Lemon & Ginger

Camomile

Raspberry & Peach

Rooibos & Apple

Red Berry Crush



BEVERAGE BLENDERS



The Quiet One®

The Quiet One is our quietest machine, offering noise-reduction technology, six optimized programs, and an Advance container for large batch sizes, and traceability options.

Power :	220-240v - 1phase / 50-60Hz
Dimensions :	W216 x D272 x H458 (mm)



Touch & Go Advance®

The Touch & Go Advance offers a powerful motor, convenient pre-set controls, and noise reduction for smaller-volume shops.

Power :	220-240v - 1phase / 50-60Hz
Dimensions :	W237 x D267 x H493 (mm)



Drink Machine Advance

high-impact, clear/stackable advance container and blade, (black base) preprogrammed with 6 programs; fully programmable.

Power :	220-240v - 1phase / 50-60Hz
Dimensions :	W203 x D229 x H493 (mm)



FOOD PREPARATION BLENDERS



Vitamix XL®

The industry's most efficient, large-capacity machine with a -4.2horsepower motor and a -1.5gallon container.

Power :	220-240v - 1phase / 50-60Hz
Dimensions :	W216 x D483 x H460 (mm)



Vita-Prep® 3

With enhanced power and larger cooling fan, you can chop prep time with culinary precision.

Power :	220-240v - 1phase / 50-60Hz
Dimensions :	W204 x D229 x H516 (mm)





TRADITIONAL COFFEE MACHINES



la marzocco

handmade in florence



LEVA X 1 GROUP

is a cutting-edge café centerpiece that encourages engagement, barista experimentation and coffee conversations, while delivering the world's best coffee extraction.

Dimensions: W520 x D645 x H775 (mm)

Power :	220v - 1phase / 380v - 3phase / 2300 w
Water :	Direct water line connection



LEVA S

Ideal espresso machine for the most elegant and classic cafés. Equipped with a CPU board and designed for superior temperature control

2 Group Dimensions: W800 x D645 x H775 (mm)
3 Group Dimensions: W1020 x D645 x H775 (mm)

Power :	220v - 1phase / 380v - 3phase / 5480 - 6780w
Water :	Direct water line connection



LEVA X

Leva re-invents the iconic lever machine design with more ergonomic elements.

2 Group Dimensions: W800 x D645 x H775 (mm)
3 Group Dimensions: W1020 x D645 x H775 (mm)

Power :	220v - 1phase / 380v - 3phase / 5700 - 7800w
Water :	Direct water line connection



STRADA MP

The Strada MP is the most advanced machine featuring traditional La Marzocco technology.

2 Group Dimensions: W800 x D675 X H475 (mm)
3 Group Dimensions: W1000 x D675 X H475 (mm)

Power :	220v - 1phase / 380v - 3phase / 4600- 8120w
Water :	Direct water line connection



STRADA AV

User-friendly interface; For customers who appreciate the familiarity of volumetric controls, repeatability and consistency in high-volume settings

2 Group Dimensions: W800 x D675 X H475 (mm)
3 Group Dimensions: W1000 x D675 X H475 (mm)

Power :	220v - 1phase / 380v - 3phase / 4600 - 8120w
Water :	Direct water line connection

*Note: Single phase power requirement is upon request



LINEA CLASSIC S AV

The Linea Classic performs reliably in high-volume settings and is perfect for your new cafe, bar, or restaurant.

- 2 Group Dimensions: W690 x D560 x H455 (mm)
- 3 Group Dimensions: W930 x D560 x H455 (mm)
- 4 Group Dimensions: W1170 x D560 x H455 (mm)

Power :	220v - 1phase / 380v - 3phase / 3350 - 9470w
Water :	Direct water line connection



LINEA PB AV High

Introduces a new level of performance, reliability, and craftsmanship, equipped with exclusive, user friendly interface software.

- 2 Group Dimensions: W710 x D590 x H533 (mm)
- 3 Group Dimensions: W950 x D590 x H533 (mm)
- 4 Group Dimensions: W1190 x D590 x H533 (mm)

Power :	220v - 1phase / 380v - 3phase / 3750 - 9470w
Water :	Direct water line connection



GB5 X AV HIGH

The GB5 X is designed with traditional European style and is dedicated for those locations with an eye on classic aesthetics but that still demand the highest level of performance.

- 2 Group Dimensions: W770 x D640 x H470 (mm)
- 3 Group Dimensions: W970 x D640 x H470 (mm)
- 4 Group Dimensions: W1210 x D640 x H470 (mm)

Power :	220v - 1phase / 380v - 3phase / 3730 - 9470w
Water :	Direct water line connection



KB90

The ultimate workflow machine, a new standard in high volume café performance.

- 2 Group Dimensions: W810 x D620 x H450 (mm)
- 3 Group Dimensions: W1050 x D620 x H450 (mm)

Power :	220v - 1phase / 380v - 3phase / 5700 - 7800w
Water :	Direct water line connection

*Note: Single phase power requirement is upon request

TEMPESTA

BARISTA ATTITUDE

Boncafe Middle East - Certified Service and Sales Partner in UAE



TEMPESTA MULTIBOILER

Brings to center stage the Barista Attitude concept through a gestural expressiveness that is fluid and meaningful around this machine of strong character.

2 Group Dimensions: W1035 x D618 X H500 (mm)
3 Group Dimensions: W1175 x D675 X H435 (mm)

Power :	380v - 3 phase / 50 / 60 Hz
Water :	Direct water line connection



TEMPESTA GARA

Brings to center stage the Barista Attitude concept through a gestural expressiveness that is fluid and meaningful around this machine of strong character.

2 Group Dimensions: W1035 x D618 X H500 (mm)
3 Group Dimensions: W1175 x D675 X H435 (mm)

Power :	380v - 3 phase / 50 / 60 Hz
Water :	Direct water line connection



SLAYER®

espresso machines

Boncafe Middle East - Certified Service and Sales Partner in UAE



STEAM LP

Provides access to easy manual pressure profiling and excellent espresso extraction.

2 Group Dimensions: W890 x D710 X H432 (mm)
3 Group Dimensions: W1130 x D710 X H432 (mm)

Power :	380v - 3 phase / 50 / 60 Hz
Water :	Direct water line connection



STEAM EP

With individual brew boilers, no steam valve rebuilds and easy to program volumetric output this is the benchmark for specialty coffee espresso machines.

2 Group Dimensions: W890 x D710 X H432 (mm)
3 Group Dimensions: W1130 x D710 X H432 (mm)

Power :	380v - 3 phase / 50 / 60 Hz
Water :	Direct water line connection



Turquoise Blue

Glossy White

Bone Beige

Matte Black



ESPRESSO V3

Uncompromisingly manual and completely focused on extraction, only espresso machine that lets you precisely and consistently control the flow rate of water allowing you to grind coffee finer and develop incredible flavor profiles.

2 Group Dimensions: W775 x D675 X H435 (mm)
3 Group Dimensions: W1030 x D675 X H435 (mm)

Power :	380v - 3 phase / 50 / 60 Hz
Water :	Direct water line connection



ESPRESSO SINGLE GROUP

A Single Group version of the Slayer Espresso. We've taken just enough out to make it fit on a standard home kitchen counter and run on 110v power

Group Dimensions: W470 x D580 X H330 (mm)

Power :	240v - 1phase / 50/60 Hz
Water :	Direct water line connection

FAEMA

Boncafe Middle East - Certified Service and Sales Partner in UAE



E71 TOUCH

Provides access to easy manual pressure profiling and excellent espresso extraction.

2 Group Dimensions: W890 x D710 X H432 (mm)
3 Group Dimensions: W1130 x D710 X H432 (mm)

Power :	380v - 3 phase / 50 / 60 Hz
Water :	Direct water line connection



E71 E

With individual brew boilers, no steam valve rebuilds and easy to program volumetric output this is the benchmark for specialty coffee espresso machines.

2 Group Dimensions: W890 x D710 X H432 (mm)
3 Group Dimensions: W1130 x D710 X H432 (mm)

Power :	380v - 3 phase / 50 / 60 Hz
Water :	Direct water line connection



PRESIDENT GTI 5 Button

With independent coffee boilers you can manage different origins of coffee respecting the specific temperatures and the infusion times of each one.

2 Group Dimensions: W820 x D630 X H505 (mm)
3 Group Dimensions: W1040 x D630 X H505 (mm)

Power :	380v - 3 phase / 50 / 60 Hz
Water :	Direct water line connection



PRESIDENT GTI TOUCH

With independent coffee boilers you can manage different origins of coffee respecting the specific temperatures and the infusion times of each one

2 Group Dimensions: W820 x D630 X H505 (mm)
3 Group Dimensions: W1040 x D630 X H505 (mm)

Power :	240v - 1phase / 50/60 Hz
Water :	Direct water line connection

Back Panel:



E71 TOUCH



E71 E



PRESIDENT GTI

TRADITIONAL COFFEE MACHINES



Espresso coffee machines since 1920

D. MBV

Its the top model of the D. Collection and it incorporates pressure profiling technology, which allows the barista to precisely regulate the pressure profile, adjustable for every dose in each coffee dispenser group.

2 Group Dimensions: W 765 x D 570 X H 515 (mm)

Power :	380v - 3phase/ 7250 - 330w
Water :	Direct water line connection



20/20 TOP

20/20 Top uses a practical new ergonomic keypad with five backlit rapid-response keys for each group. Each keypad is connected to a new graphic display with extra commands.

2 Group Dimensions: W720 x D545 X H470 (mm)
 3 Group Dimensions: W960 x D545 X H470 (mm)
 4 Group Dimensions: W1200 x D545 X H470 (mm)

Power :	380v - 3phase / 3500 -9000w
Water :	Direct water line connection



20/20 SPACE TOP

space-saving version of 20/20 Top with practical new ergonomic keypad with five backlit rapid-response keys for each group.

2 Group Dimensions: W570 x D545 X H470 (mm)

Power :	380v - 3phase / 3500w
Water :	Direct water line connection



20/20 CLASSIC

This machine offers clear, simple functions. 20/20 Classic uses a practical new ergonomic keypad with five backlit rapid-response buttons for each group.

2 Group Dimensions: W720 x D545 X H470 (mm)
 3 Group Dimensions: W960 x D545 X H470 (mm)
 4 Group Dimensions: W1200 x D545 X H470 (mm)

Power :	380v - 3phase / 3500 -9000w
Water :	Direct water line connection



20/20 PLUG & PLAY 1grp

This -1group machine is easy to use, with a double boiler for extremely precise coffee extraction, and is suitable for a wide range of uses: from bars to offices, small restaurants and B&Bs, and even at home.

Dimensions: W380 X D545 X H470 (mm)

Power :	380v - 1phase / 2000w
Water :	Direct water line connection



NEW 105 Touch

The flow variator that gives the possibility to modify the brewing temperature in every group in NEW 105

2 Group Dimensions: W790 x D535 X H515 (mm)
 3 Group Dimensions: W1030 x D535 X H515 (mm)

Power :	380v - 3phase / 4500 - 7000w
Water :	Direct water line connection



100 Touch

100 Touch adapts a thermosiphonic circulation system with pre-infuser and flow variator.

2 Group Dimensions: W735 x D570 X H515 (mm)
 3 Group Dimensions: W975 x D570 X H515 (mm)

Power :	380v - 3phase / 4500 - 7000w
Water :	Direct water line connection

*Available NEW 105 E (Electronic Version)



100 Touch Sprint

100 Touch sprint is a compact edition of 100 touch series.

2 Group Dimension: W650 x D570 x H515 (mm)

Power :	380v - 3phase / 3000 - 4500w
Water :	Direct water line connection



100 Practical T

Touch technology display that permits a very ergonomic use of the keyboard (touch brewing selection) and that gives very useful information to the user.

1 Group Dimensions: W410 x D570 x H515 (mm)

Power :	220v - 1phase / 2000w
Water :	2.5 litre water tank



Infrared Optical Sensor

SM TK Smart Instant Espresso Grinder

Advance new internal system detects which type portafilter is used and prepress the exact portion for single or double shot of espresso without pressing any button.

Dimensions: W200 x D355 X H610 (mm)

Power :	220v - 1phase / 650w
---------	----------------------



SM 97 Instant Espresso Grinder

on demand (fresh ground) dosing coffee grinders with electronic dose adjustment.

Dimensions: W200 x D355 X H570 (mm)

Power :	220v - 1phase - 460w
---------	----------------------

CAFE AT HOME



la marzocco
HOME

the iconic design and performance of a la marzocco comes home.



LINEA MINI

Comes with dual boilers and an integrated brew group that allows the machine to achieve the temperature stability and energy efficiency.

Dimensions: W357 x D453 x H377 (mm)

Power :	220-240v - 1phase / 1620 - 1820w
Water :	2.5 litre water tank



GS3 MP (Mechanical Paddle)

This Coffee Machine puts the innovation and technology of commercial grade La Marzocco machines within reach of home baristas.

La Marzocco technology and translate it for a home espresso machine.

The GS3 features the thermal stability system used in the La Marzocco S trada, including a preheating system, digital PID controller, saturated groups, a dual-boiler system, and digital display.

Mechanical Paddle: The new conical mechanical paddle is inspired by the original mechanical group used on the La Marzocco GS – the first dual-boiler espresso machine with saturated groups (1970).



GS3 MP / GS3 AV

Dimensions: W400 x D530 x H355 mm

Power :	220v - 1phase / 1620 - 2120w
Water :	2.5 litre water tank

GS3 AV (Auto Volumetric)

This model allows for programmable pre-infusion and water metering. As a result, you can pull consistently delicious shots

CAFE AT HOME

ECM

MANUFACTURE

HOME LINE



Mechanika VI Slim

Our small allrounder in a compact design with new options!

Heat Exchanger System with Vibration Pump

Dimensions: W250 x D445 x H395 (mm)

Power	230v - 1 Phase / 1400w
Water tank	approx. 2.8 l



Technika V Profi PID

Heat Exchanger System with Rotary Pump

Sophisticated technology in exceptional design

Dimensions: W325 x D475 x H390 (mm)

Power	230v - 1 Phase / 1400w
Water tank	approx. 3 L



Synchronika

Dual Boiler System with Rotary Pump

Pure Lifestyle

Dimensions: W335 x D490 x H410 (mm)

Power	230v - 1 Phase / 1600w
Water tank	approx. 2.8 L

ECM ACCESSORIES



ECM Portafilter



ECM Tamper



ECM Tamper Station (height adjustable)



ECM Tamper Station (Polished Ring insert)



ECM Milk Jug (0.36L | 0.60L)



ECM Barista cloth



ECM Leveler Tamper



ECM Distributor



ECM Knockout Box

FAEMINA

Boncafe Middle East - Certified Service and Sales Partner in UAE



FAEMINA

The most advanced technologies of the professional world for the home&small business.

1 Group Dimensions: W377,5 x D517,5 X H413,5 (mm)

Power :	220 - 240 V 50/60 HZ
Water :	2.5 L Water tank

*Direct water line connection option



E 61 JUBILE

The automatic version features dosed hot water and beverage selections to simplify your work.

1 Group Dimensions: W550 x D540 X H565 (mm)
2 Group Dimensions: W715 x D540 X H565 (mm)

Power :	380v - 3 phase / 50 / 60 Hz
Water :	Direct water line connection



E 61 LEGEND

The iconic E61 Legend professional machine is celebrating its anniversary with a single-phase version that is also suitable for home installation.

1 Group Dimensions: W550 x D540 X H565 (mm)
2 Group Dimensions: W715 x D540 X H565 (mm)

Power :	380v - 3 phase / 50 / 60 Hz
Water :	Direct water line connection

CUSTOMIZED COFFEE MACHINES

GB 2 5GROUP



STRADA AV 2GROUP



GS3 AV 1GROUP / K30 VARIO



GS3 AV 1GROUP



KB2 90GROUP



BLACK EAGLE 2GROUP

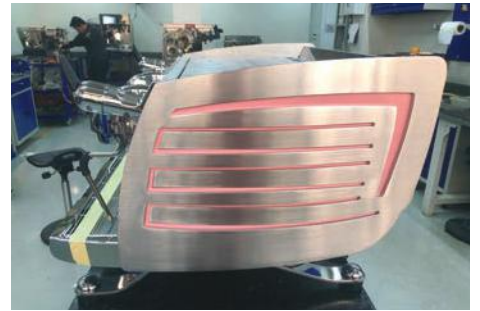

LINEA PB 2GROUP



LINEA PB 2GROUP



STRADA AV 2 GROUP



CUSTOMIZATION

Stand out with customized espresso machine and espresso grinder.

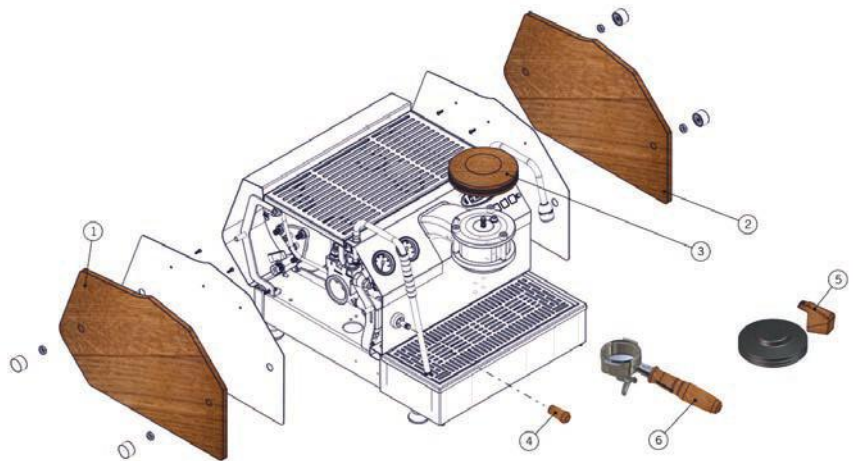

Walnut



American
Oak



Standard
RAL Color Code

*Terms and conditions may apply

COFFEE GRINDERS



E65S Espresso Grinder

The E65S is the perfect synergy of proven premium espresso grinding technology and pioneering features, designed to meet the modern demands of coffee professionals around the globe.

Power:	220-240v - 1phase / 440w
Dimensions:	W195 x D283 x H583 (mm)



E80S Espresso Grinder

For coffee shops or individual baristas who are looking for high-quality, reproducible and accurate grinding results, MAHLKÖNIG's E80 Supreme is the fastest and most advanced premium espresso grinder in the market.

Power:	220-240v - 1phase / 800w
Dimensions:	W240 x D340 x H630 (mm)



E65S GbW

ESPRESSO GRINDER GRIND BY WEIGHT is the next espresso grinding revolution. It is the first espresso grinder ever, that features Grind-by-Weight technology for real-time scale controlled dosing.

Power:	220-240v - 1phase / 690w
Dimensions:	W283 x D445x H620 (mm)



E80 GbW Espresso Grinder

It is the first espresso grinder ever, that features Grind-by-Weight Technology for real-time scale controlled dosing as well as Mahlkönig's pioneering patented Disc Distance Detection that lets you set the degree of fineness based on the actual distance between the burrs

Power:	220-240v - 1phase / 690w
Dimensions:	W240 x D320 x H550 (mm)



Guatemala Shop Grinder

The classic went through a face-lift while keeping loved and proven technical specifications.

Power:	220-240v - 1phase / 1100w
Dimensions:	W220 x D33 x H620 (mm)

COFFEE GRINDERS



EK43S

The EK43 provides the most even extraction of the coffee's valuable aroma and is known to be a guarantor for an outstanding taste experience and a symbol for quality.

Power :	220-240v - 1phase / 1300w
Dimensions :	W230 x D410x H680 (mm)



EK43 / EK43T

The EK43 provides the most even extraction of the coffee's valuable aroma and is known to be a guarantor for an outstanding taste experience and a symbol for quality.

Power :	220-240v - 1phase / 1300w
Dimensions :	W230 x D410 x H830 (mm)

HOME GRINDERS MACHINE



X54

The X54 Allround Home Grinder is the home barista's gateway to pro-level grinding and more delicious coffee.

Power :	220-240v - 1phase / 1300w
Dimensions :	W230 x D410x H680 (mm)



H1 allround Grinder

Grind for any brew method with ease makes it even easier to brew espresso, plus all your favorite filter methods with the turn of a dial.

Power :	240-220v - 1phase / 200W
Dimensions :	L230 x W138 x H470 mm



Lux D Espresso Grinder

The Lux D grinder is the result of a collaboration between La Marzocco Home and Mazzer to build an optimized home espresso grinder.

Power :	220-240v - 1phase / 250 Watt
Dimensions :	W180 x D250x H475 (mm)



CUSTOM COLOR

Black

White



EPRESSO AV / EP

The most consistent and stable under-counter espresso machine available.

Dimensions: TAP 140 x 320 x 360 mm
 MOD 410 x 220 x 380 mm

Power:	220 - 240v - 1 phase / 1520 - 3300w
Water:	Direct water line connection



POUR-OVER

Maintain full control with manual brewing and programmed pulse recipes on the counter.

Dimensions: TAP 180 x 230 x 450 mm
 MOD 410 x 360 x 140 mm

Power:	220 - 240v - 1 phase / 3000w
Water:	Direct water line connection



STEAM

Modbar Steam delivers a minimal, modern aesthetic coupled with power and control.

Dimensions: TAP 90 x 320 x 340 mm
 MOD 410 x 360 x 220 mm

Power:	220 - 240v - 1 phase / 3310w
Water:	Direct water line connection





Black&White4 NEO CTMS

The well-rounded CTMS is the milk foam pro in the neo group. It processes dairy or plant-based milk from the tank, or you can use the steam wand to produce premium foam – hot or cold.

Capacities: 120 espressos / 78 coffees / 79 cappuccinos / 99 teas
Amount depends on cup size and machine setting
Bean hopper/one grinder 750g/1200g

Machine Dimensions: W565 x D580 X H555 (mm)

Power :	220-240v - 1 phase / 50 / 60 Hz
Water :	Direct water line connection



Black&White4 NEO CTMS

Classic coffee and milk specialities, the CTM will keep coffee connoisseurs content.

Capacities: 120 espressos / 78 coffees / 79 cappuccinos / 99 teas
Amount depends on cup size and machine setting
Bean hopper/one grinder 750g/1200g

Machine Dimensions: W565 x D580 X H555 (mm)

Power :	220-240v - 1 phase / 50 / 60 Hz
Water :	Direct water line connection



Black&White4 NEO CTS

Equipped with a steam wand that will enable you to make barista-quality foam from practically any kind of milk. Perfect for alternative, plant-based milk varieties

Capacities: 120 espressos / 78 coffees / 99 teas
Amount depends on cup size and machine setting
Bean hopper/one grinder 750g/1200g

Machine Dimensions: W345x D580 X H(555)505 (mm)

Power :	220-240v - 1 phase / 50 / 60 Hz
Water :	Direct water line connection



Black&White 4 CTMplus

The solution for every type of milk! the new option for the powerful Black&White4 is unique on the market and enables the processing of any type of milk-animal or vegetable - at the touch of a button.

Bean hopper - 1.7kg ? RL Refrigerator 9 liters / Plus multi option

Machine Dimensions: W646x D600 X 692 (mm)

Power :	380v- 3phase / 4500 - 7000w
Water :	Direct water line connection



Black&White4 CTM P / CTM P RL

Quick and easy hot or cold chocolate milk with the CTM P/CTM P RL. Don't miss out on putting a fine-pore, creamy milk foam on top.

Bean hopper ~1.7 kg / RL refrigerator 9 liters / Powder container 2 kg

Machine Dimensions: W692 x D600 x H645 mm (with RL)

Power :	220-240v -1Phase / 7100w
Water :	Direct water line connection



Black&White4 CTM RL

With the built-in RL refrigeration unit, which can hold 9 litres of cooled milk, the CTM RL is the perfect choice for preparing both hot and cold coffee and milk drinks..

Bean hopper ~1.7 kg / RL refrigerator 9 liters

Machine Dimensions: W600 x D600 x H645 mm (with RL)

Power :	220-240v -1Phase / 7100w
Water :	Direct water line connection



Black&White4 Compact CTM / CTM RS

CTM RS brings together what belongs together and combines excellent coffee and milk foam know-how.

Capacities: 180 espresso / 120 coffee / 100 cappuccino / 90 tea
Bean hopper ~ 1 kg / RS refrigerator 4 liters

Machine Dimensions: W398 x D600 x H646 mm (with RS)

Power :	220-240v -1Phase / 3150w
Water :	Direct water line connection



Black&White4 Compact CTM P / CTM P RS

CTM P/CTM P RS creates hot chocolate with a simple touch of a button and tops it off with creamy, smooth milk foam.

Capacities: 180 espresso / 120 coffee / 100 cappuccino / 90 tea / 80 chocolate
Bean hopper~1 kg / RS refrigerator 4 liters / Powder container 2 kg

Machine Dimensions: W490 x D600 x H646 mm (with RS)

Power :	220-240v -1Phase / 3150w
Water :	Direct water line connection



Black&White4 Compact CTM PF / CTM PF RS

CTM PF/CTM PF RS meets every demand. With the powder and flavor units for chocolate powder and syrup flavors coffee and milk specialties obtain an individual flavor.

Capacities:180 espresso / 120 coffee / 100 cappuccino / 90 tea / 80 chocolate
Bean hopper 1 kg / RS Refrigerator 4 litres.

Machine Dimensions: W660 x D600 x H646 mm (with RS)

Power :	220-240v -1Phase / 3150w
Water :	Direct water line connection



CH Cup Warmer

The cup warmer CH coffee mugs are perfectly pre-heated – the ideal basis for perfect coffee.

Capacities: Storage of 100 to 150 cups

Machine Dimensions: W246 x D490 x H483 mm

Power :	220-240v -1Phase / 110w
---------	-------------------------

CaféMATIC



CAFÉMatic 2

Ideal coffee machine models for any small and medium businesses.

Machine Dimensions: W410 x D500 x H580 (mm)

Power :	220 / 240v - 1phase / 3100w
Water :	8 litre water tank / Direct Option



CAFÉMatic 5

Designed for specialised needs and can provide personalised preferences with various beverage products with steam heating and milk frothing capabilities.

Machine Dimensions: W642 x D340 X H545 (mm)

Power :	240 / 220v - 1phase / 2900w
Water :	4 litre water tank



CAFÉMatic 6

designed to deliver a range of high quality and rich flavour that would elevate your coffee experience.

Machine Dimensions: W340 x D540 X H775 (mm)

Power :	220 / 240v - 1phase / 3800w
Water :	4 litre water tank / Direct Option



CAFÉMatic 8

designed to deliver a range of high quality and rich flavour that would elevate your coffee experience. With powder option.

Machine Dimensions: W340 x D540 X H775 (mm)

Power :	220 / 240v - 1phase / 3800w
Water :	4 litre water tank / Direct Option

OFFICE COFFEE SOLUTION



BOOK FOR TASTING



CHOOSE YOUR MACHINES



SELECT YOUR BLENDS



PLACE YOUR ORDER



Saeco Phedra Evo Cappuccino

The new design solutions were developed to facilitate its use and to be able to choose among 7 types of beverages, besides hot water for tea or herbal teas.

Machine Dimensions: W393 x D508 X H695 (mm)

Power:	220 / 240v - 1phase / 1550w
Water:	2.5 litre water tank



Saeco AREA

a professional OCS capsule coffee machine which, for its compact size and rigorous but modern style, can adapt to all small and medium locations.

Machine Dimensions: W280 x H380 x D480 mm

Power:	220 / 240v - 1phase / 1550w
Water:	2.5 litre water tank



SC08 Milk Cooler

Dimensions: W220 x D452 x H456 (mm)
Inner Dimensions: W160 x D190 x H280 (mm)

Power:	240-220V/50Hz/60 watts
Capacity:	21litres



Thermoelectric Milk Cooler

Counter top cooler (6 litre capacity)

Power:	230v - 1phase / 33w
--------	---------------------



CBS-1221 Automatic Airpot Brewer

Streamline coffee service with a Fetco CBS-1221 automatic airpot brewer with large metal brew basket! Brewing an impressive (128) 8 oz. cups of coffee per hour, this automatic airpot is ready to work.

Machine Dimensions: W235x D565 X H660 (mm)

Power :	220-240v - 1 phase / 50 / 60 Hz
Water :	Direct water line connection



D080 PUMP LEVER AIRPOT

The 2.2L pump lever airpot is an economical, convenient and safe solution for light duty self-serve beverage dispensing.

Machine Dimensions: W235x D565 X H660 (mm)



CBS-2152

Coffee Brewer provides flexibility in medium-to-large sized venues such as Banquet Halls, Cafeterias, and Restaurants.

Machine Dimensions: W555x D585 X H935 (mm)

Power :	220-240v - 1 phase / 50 / 60 Hz
Water :	Direct water line connection



D449 Thermal Dispenser

The L4D Series LUXUS Thermal Coffee Stainless Steel, 1.5 gal Dispensers are a stylish self-serve option for hotel lobbies, breakrooms, cafes, quick-serve restaurants, office coffee service, C-Stores, and anywhere cups per hour volume is light or countertop space is limited.

AUTOMATIC TAMPER



Q1 Automatic Tamper

Most straight forward model and delivers an incredible even tamp in just 1.3 seconds.

All types of portafilters. Naked, Single sprout and double sprouts.

Tamper Diameter: 58 mm
 Tamper shape: flat bottom
 Adjustable pressure: 10 - 30 kg (+/- 1kg)

Power :	220-240v - 1phase / 60w
Dimensions :	W125 x D150 x H220 (mm)



Q2 Automatic Tamper

Contains our most advanced technology and does everything a Barista could wish for.

All types of portafilters. Naked, Single sprout and double sprouts.

Tamper Diameter: 58 mm
 Tamper shape: flat bottom
 Adjustable pressure: 10 - 30 kg (+/- 1kg)

Power :	220-240v - 1phase / 60w
Dimensions :	W125 x D150 x H220 (mm)



PuoqPress MINI

MINI looks as stunning as his bigger siblings with it's premium colors & matt finishing

All types of portafilters. Naked, Single sprout and double sprouts.

Tamper Diameter: 58,3 – 53,0mm
 Tamper shape: flat bottom
 Adjustable pressure: 10 - 30 kg (+/- 1kg)

Power :	220-240v - 1phase / 60w
Dimensions :	W136 x D181 x H272 (mm)



M1 Automatic Tamper

Designed to fit under your K30 or Peak BY MAHLKÖNIG & DITTING

Power :	220-240v - 1phase / 72w
Dimensions :	W230 x D300 x H17 (mm)



M2 Automatic Tamper

Designed to fit under your MYTHOS 1 & -2 BY VICTORIA ARDUINO AND SIMONELLI

Power :	220-240v - 1phase / 72w
Dimensions :	W28.5 x D38 x H17 (mm)



M3 Automatic Tamper

Designed to fit under your E65S & E65S GBW BY MAHLKÖNIG

Up to 10 kg of coffee per week

Power :	220-240v - 1phase / 72w
Dimensions :	W194 x D283 x H147 (mm)



El Bandido Panini Press

The first rapid cook oven that can operate as a high-speed/high-quality panini press with the flexibility to rapidly cook nonpressed foods.

The panini press is externally actuated so the operator can choose to press a product.

Machine Dimensions: W406 x D (993) 658 X H635 (mm)

Power :	230v - 3ph / 60 Hz / 20 amps

The SOTA i1

The Sota oven provides superior speed and cooking performance in TurboChef's smallest, most energy-efficient package.

Machine Dimensions: W406 x D 757 X H635 (mm)

Power :	230v - 3ph / 60 Hz / 20 amps



The ECO

Small but %100 TurboChef

The Eco oven is the most energy-efficient TurboChef oven and our smallest footprint – only 16inches wide, 22 inches deep.

Machine Dimensions: W555x D585 X H935 (mm)

Power :	230v - 1ph / 60 Hz / 16amps
Water :	Direct water line connection

i3

The i3 oven maximizes throughput and versatility with its large cavity size and ability to cook with most any metal pan up to a half-size sheet pan.

Machine Dimensions: W622 x D792 X H540 (mm)

Power :	230v - 3ph / 60 Hz / 20 amps



i5

The i5 oven maximizes throughput and versatility with its large cavity size and ability to cook with most any metal pan up to a full-size hotel or gastronome pan.

Machine Dimensions: W714 x D718 X H618 (mm)

Power :	230v - 3ph / 60 Hz / 20 amps



The Double Batch

The Double Batch oven has two independent cavities that circulate impinged air at speeds of up to 50 mph to create high heat transfer rates and reduced cook time. The oven utilizes variable speed blowers, oscillating racks, and catalytic converter, resulting in minimal energy input, high food quality, and ventless operation.

Machine Dimensions: W704x D805 X H589 (mm)

Power :	230v - 1ph / 60 Hz / 16amps
Water :	Direct water line connection



OTHER EQUIPMENT



FRIIA RANGE



FRIIA C

Dimensions Inc. Drip tray :	D168xW112xD284 (mm)
Dimensions Excl. Drip tray:	D137xW27x284(mm)

FRIIA C TALL / FRIIA C HANDS FREE

Dimensions Inc. Drip tray :	D168xW112xD343 (mm)
Dimensions Excl. Drip tray:	D137xW27xD343 (mm)

BOILER for FRIIA



MIX UC3

Dimensions Inc. Drip tray :	D384xW208xH442 (mm)
Power:	220 - 110v - 1phase - 1.400kw

MIX UC8

Dimensions Inc. Drip tray :	D384xW208xH615 (mm)
Power:	220v - 1phase - 2800kw

CHILLER for FRIIA



CHILLER / CHILLER CARBONATOR

Dimensions Inc. Drip tray :	D434xW259xH455 (mm)
Power:	110v - 1phase - 180w

COFFEE BREWERS



SP9 SINGLE



SP9 TWIN



SP9 BOILER

SP9 SINGLE / SP9 TWIN

COLOR OPTIONS:  BLACK  WHITE

Dimensions (per head):	D191xW132xH419 (mm)
Power:	230v - 1phase - 2400kw

SP9 BOILER

Dimensions:	D394xW152xH564 (mm)
Power:	230v - 1phase - 2400kw

ECOBOILER COUNTERTOP WATER BOILERS/TAP



ECO BOILER T5

Dimensions:	D555xW210xH465 (mm)
Power:	230v - 1phase - 2800kw



ECO BOILER T10

Dimensions:	D570xW240xH690 (mm)
Power:	230v - 1phase - 2800kw



ECO BOILER T20

Dimensions:	D463xW210xH590 (mm)
Power:	230v - 1phase - 2800kw



ECO BOILER T30

Dimensions:	D570xW300xH690
Power:	230v - 1phase - 5600kw

OTHER EQUIPMENT



Elite Coffee Capsule

Small coffee machine with capsules or pods; 2 doses of coffee, espresso and long coffee, self-shutdown system for energy saving; small size for the home, small office and hotel rooms.

Machine Dimensions: W100 x D320 x H260 (mm)

Power :	220 / 240v - 1phase / 800w
Water :	1 litre water tank

كافئ تركش
CAFÉ TURKISH



TKM 8961 K

Turkish Coffee Machine (6 Cup)

Power :	220-240v - 1phase / 1100w
Dimensions :	W320xL390xH230 (mm)



BEKO 2300

Turkish Coffee Machine Mini (3 Cup)
Cook Sense™ Technology

Power :	220-240v - 1phase / 60w
Dimensions :	W157xD179xH237 (mm)



CleanBean

Designed to remove the build-up of coffee residues and oils in the brewing chamber and delivery spout of a capsule machines.



Espresso Clean

Cleaning powder suitable for traditional coffee machines



F20

Cleaning powder suitable for automatic coffee machines



Grinder Clean

Cleaning tablets suitable for Espresso Grinder



Restore

Descaling sachets for coffee machines



MFC

Liquid milk frother cleaner



Organic Descaler

Decalcify (delime or descale) espresso machine water tanks and coffee brewing equipment.

thermoplan



Thermo Milk Tabs

Milk system cleaning tablets for Black and White 3 coffee machines.



Black & White Tabs

Cleaning tablets designed for use on Thermoplan Black and White 3



Thermo Coffee Tabs

Cleaning tablets designed for use on Thermoplan Black and White 4c coffee machines.

ACCESSORIES



Frothing Thermometer



Electric Timer



Chocolate Shaker



Measuring Shot Glass



Boncafé Ceramic Cups

- 4 Espresso cups and saucers
- 4 Morning cups and saucers
- 4 Cappuccino cups and saucers
- 4 Latte glasses



Boncafé Paper Cups

- Available in 16oz with flat or dome lids

Boncafé Plastic Cups

- Available in 4oz & 8oz with plain lids

Straws



Porcelain Cups

- 3 Espresso cups and saucers
- 4 Regular cups and saucers
- 2 Large cups and saucers



Paper Cups

- Available in 4oz, 8oz, 12oz, & 16oz with lids

SPECIALTY COFFEE SOLUTION



COLD DRIP
TOWER



BLACK PEAL
SMART SCALE



V60 DRIP SCALE



V60 METAL DRIP
SCALE



AEROPRESS



AEROPRESS REPLACEMENT
FILTERS



CHEMEX 3-1 CUP (PINT)
COFFEE MAKER



CHEMEX 6 CUP
COFFEE MAKER



CHEMEX - BONDED FILTERS
HALF MOON



CHEMEX BONDED FILTERS
PRE - FOLDED CIRCLE 6 CUP



CHEMEX BONDED WHITE
SQUARE COFFEE FILTERS

Perfect for specialty cafes, boutiques, restaurants and hotels

MACHINES

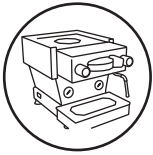

MODBAR

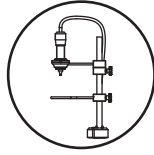

GRINDERS

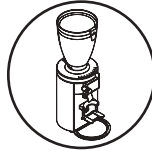

BARISTA TOOLS



SERVICE & MAINTENANCE



V60 DRIPPER NO.2
COPPER



COFFEE POWDER AMERICAN
BRUSH (SPIRIT)



V60 DRIPPER NO.1
CERAMIC WHITE



COFFEE KNOCK OUT BOX
DRAWER

*Stainless Steel Available



V60 FILTER CUP



BLACK SILICON TAMPER MAT



V60 COFFEE PAPER
FILTER 01



GLASS WASHER



V60 COFFEE PAPER
FILTER 02



COFFEE TAMPER



RANGE SERVER 360 ML



FROTHING JUG



SMELLING CUP (EK43)



DISTRIBUTING TOOL
PULP TYPE TAMPER

**THINK, TALK,
AND BREW
SOMETHING
GREAT TOGETHER**





**REVERSE OSMOSIS SYSTEM
BWT bestaqua 14 ROC COFFEE**

Is the new unique tool for round the clock perfect water using reverse osmosis.

BWT bestaqua PREMIUM 14
BWT bestaqua MEMBRANE 14
BWT besttaste

Dimension W280 x D280 x H500 mm

Power :	220-240v -1Phase / 3150w
Water :	Direct water line connection

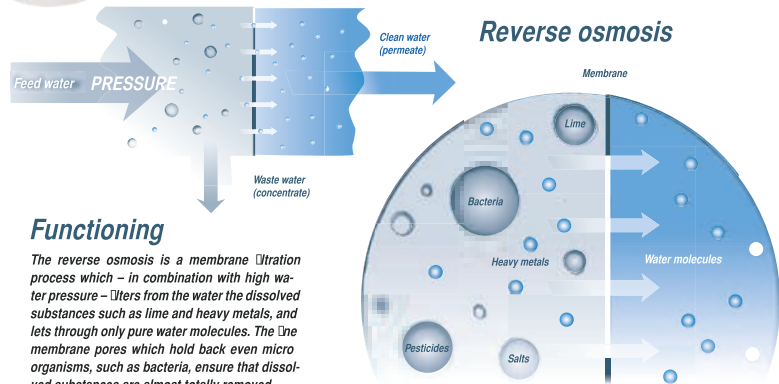

Functioning

The reverse osmosis is a membrane filtration process which – in combination with high water pressure – filters from the water the dissolved substances such as lime and heavy metals, and lets through only pure water molecules. The fine membrane pores which hold back even micro organisms, such as bacteria, ensure that dissolved substances are almost totally removed.



Bestprotect Water Filter
Optimal protection against corrosion

FLOJET



Flo Jet Pump Water System
For coffee machine on trolley or for location without water outlet.



BONBARISTA | BARISTA TRAINING

Barista is a very powerful person in the coffee chain. Barista is the spokesperson for the hundreds or thousands of people who were involved with each coffee, prior to its arrival in the café or restaurant.

Barista speaks for the farmers, the processors, the roasters, the business owners, and indeed for coffee itself.

Level 1

Throughout this interactive practical session you will receive a general understanding of the history of coffee and its origin, how it's produced and the beverages that can be created from it. We will show you how to operate and maintain your machine and grinder correctly, the art of making perfect espresso and basic coffee recipes.

VIDEO



Video Presentation: General understanding of the history of coffee and its origins.

- Coffee origins
- Types of coffee beans
- Roasting
- The art of blending
- Storing of the coffee beans

PRACTICAL



Practical and Practice sessions: Understanding your coffee machines and making your perfect Espresso.

- Operation of a semi-automatic coffee machine
- Operation and correct calibration of the grinder
- Types of barista tools
- Correct and proper Tamping
- Making a perfect Espresso shot
- How to foam and steam Milk
- Basic coffee recipes

CLEANING



Cleaning Procedures: Basic maintenance and cleaning procedures of the Coffee Machines and Equipment.

- How to clean and maintain coffee machines before and after operation
- How to clean and maintain grinders before and after operation
- How to work productively and efficiently with style and flair

Level 2

Level 2 is designed for moderately experienced Barista's and for those who have completed a Barista 101 Level 1 training and would now like to further their skills. The program offers professional guidance in creating specialty drinks and Latte Art.

VIDEO



Video Presentation: Basic and advanced techniques and extreme latte art

- Introduction to latte arts
- Equipment and barista tools required
- Different type of designs

FROTHING



Milk Frothing Techniques: Creating smooth milk for latte art and cappuccino

- Important foundation of correct milk texturing
- The correct and advanced way of frothing milk

POURING



Advanced Practical Training: Basic and advanced techniques and extreme latte art

- Milk pouring techniques for different designs



BONBARISTA | BARISTA TRAINING

Level 3

This training is designed to introduce the variety of methods, core skills and equipment required to produce great brewed coffee in cafes or at home, Learn the importance of the brewing variables that affect quality of the coffee.

PRESENTATION



Slide Show Presentation: Introduction to specialty coffee

- Bean to cup
- Processing
- Key elements of brewing
- Golden Ratio
- Brewing tools
- Filtration
- Tester flavor wheel

BREWING



Practical and Practice session: Understanding the key elements behind specialty coffee and brewing techniques

- Brewing foundation
- Basic cupping demonstration
- Difference between blends and single origin coffee
- Difference between dark and light roast
- Difference between specialty and non - specialty coffee

Certification

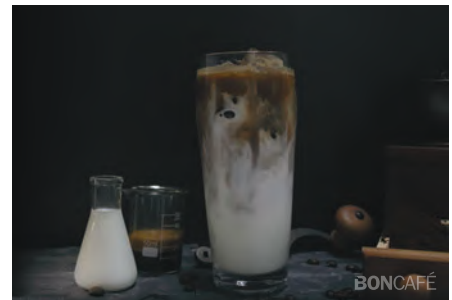

Beverages Menu Development

Menu development is available upon request for all our clients purchasing Boncafé products and with advice available on suitable products and recipes for your establishment. Boncafé will also provide training for your staff which can be conducted at our Boncafé showroom or on site at your venue.

- Creating new and unique hot and cold beverages for your menu using Boncafé products
- Providing complete specification of all recipes in a variety of cup sizes
- How to make beverages correctly according to recipe
- Provide new recipes or special drinks promotions when needed
- Correct development of menu board layout and design

Boncafé Training Room



TECHNICAL SUPPORT

BONCAFÉ

SERVICE & MAINTENANCE



YOUR LEADING COFFEE MACHINE SERVICE PROVIDER
15 Years Experience in the Coffee Industry.

Our Services

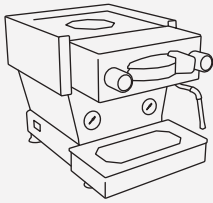

Service & Maintenance
for Commercial, Domestic
Coffee Machines



Service & Maintenance
for Commercial, Domestic
Coffee Grinders



Service & Maintenance
for Commercial Kitchen
Equipment & Refrigeration



Providing Water Treatment
Solution for Food Service
Equipment

We are fully equipped with a certified Service Team available 24 / 7. We got you covered!



SERVICE SOLUTION

- Annual Maintenance Contract
- Preventive Maintenance Contract
- Call Out Technical Support
- Spare Parts Supply



and all other major coffee machine brand!





INTERNATIONAL OFFICES

SINGAPORE

Boncafé International Pte Ltd
www.boncafe.com

THAILAND

Boncafé (Thailand) Ltd
www.boncafe.co.th

MALAYSIA

Boncafé (M) Sdn Bhd
www.boncafe.com.my

INDONESIA

PT Bon Café Indonesia
www.boncafeindonesia.com

CAMBODIA

Boncafé (Cambodia) Ltd
info@boncafe.com.kh



VIETNAM

Boncafé Vietnam Company Limited
www.boncafeven.cm

HONG KONG

Boncafé (Hong Kong) Limited
www.boncafe.com.my

CHINA

Boncafé China Limited
www.boncafe-china.com

MALDIVES

Boncafé Maldives Private Limited
www.boncafemaldives.com



Massimo Zanetti
MASSIMO ZANETTI
BEVERAGE GROUP

BONCAFÉ | **Segafredo**
ZANETTI

Sales and Inquiry

☎: +971 4 705 9000 ✉: info.bme@boncafeme.ae

Service and Technical Support

☎: +971 4 608 7000 ✉: service.dept@boncafeme.ae

🌐: www.boncafeme.ae



@boncafeme